



Phocos CIS-N-2L

Bedienungsanleitung

User Manual

Manual de Instrucciones

Guide de l'utilisateur

Manual do Usuário

用户说明书



CID: 181814812

CONTENTS

Bedienungsanleitung	1-14
User Manual	15-32
Manual de Instrucciones	33-46
Guide de l'utilisateur	47-59
Manual do Usuário	60-73
用户说明书	74-86

Bitte lesen Sie die Anweisungen sorgfältig und gründlich durch, bevor Sie das Produkt in Betrieb nehmen. Es ist ausgestattet mit einer Reihe von herausragenden Eigenschaften, wie z. B.:

- Negative Erdung
- Duale Last
- Schutzklasse: IP68 Schutz, in 1,5 m Wassertiefe 72 Stunden
- Fernbedienung (CU) für die Konfiguration des CIS Ladereglers via Infrarot-Schnittstelle
- Externer Temperatursensor für die Temperaturkompensation der Ladespannungen
- 4 stufiges Ladeverfahren (Main, Boost, Equalization, Float) für flüssigsäure-Batterien, 3 stufiges Laden (Main, Boost, Float) für Gel-Batterien
- Automatische Erkennung der Systemspannung 12/24 V
- Vielseitig programmierbar



Verbindung und Erdung

- Verbinden Sie die Kabel in der angezeigten Reihenfolge 1, 2, 3, 4, 5, 6, 7, 8 um Installationsfehler zu vermeiden
- Um Spannung an den Kabeln zu vermeiden, verbinden Sie zuerst die Kabel am Laderegler, dann an der Batterie, Modul oder Last
- Der empfohlene mind. Kabeldurchschnitt beträgt für den CIS05: 2,5 mm²; CIS10: 6,0 mm²; CIS20: 10 mm²
- Stellen Sie sicher, dass die Kabellänge zwischen Batterie und Laderegler so kurz wie möglich ist.

- Beachten Sie, dass die negativen Kabel des CIS-N miteinander verbunden werden und deshalb das gleiche elektrische Potential haben. Wenn eine Erdung benötigt wird, bitte immer an den negativen Kabeln.

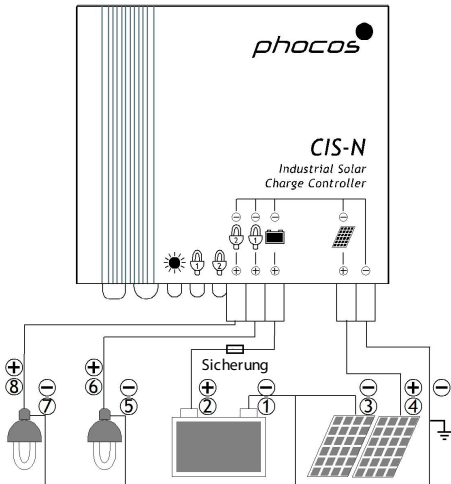
	Funktion	Kabelkennzeichnung	Kabelquerschnitt	Farbe
①	Negativer Batterieanschluss	COMMON -	2.5 mm ²	schwarz
②	Positiver Batterieanschluss	BATTERY +	2.5 mm ²	rot
③	Negativer Panelanschluss	COMMON -	2.5 mm ²	schwarz
④	Positiver Panelanschluss	SOLAR +	2.5 mm ²	gelb
⑤	Negativer Lastanschluss 1	COMMON -	2.5 mm ²	schwarz
⑥	Positiver Lastanschluss 1	LOAD 1 +	2.5 mm ²	orange
⑦	Negativer Lastanschluss 2	COMMON -	2.5 mm ²	schwarz
⑧	Positiver Lastanschluss 2	LOAD 2 +	2.5 mm ²	orange



LED	Status	Funktion
	An	Laderegler mit der Batterie verbunden, Nacht erkannt
	Blinken	Laderegler mit der Batterie verbunden, Tag erkannt
	Aus	Keine Batterie verbunden
	An	Last 1 Tiefentladeschutz/ Überspannungsabschaltung(LVD/HVD)
	Blinken	Last 1 Überstrom
	Aus	Last 1 OK
	An	Last 2 Tiefentladeschutz /Überspannungsabschaltung(LVD/HVD)
	Blinken	Last 2 Überstrom
	Aus	Last 2 OK
Alle LEDs	Grün->Rot->Grün->	Programmierung

Nachtlichtfunktion

Der CIS-N Laderegler hat eine hoch entwickelte Nachtlichtfunktion. Er kontrolliert den Lastausgang bei Nacht und ist vielseitig programmierbar. Es stehen 3 Modi zur Verfügung: Standard Laderegler-Modus, Abend- bis Morgendämmerungs-Modus und Abend/Morgen-Modus

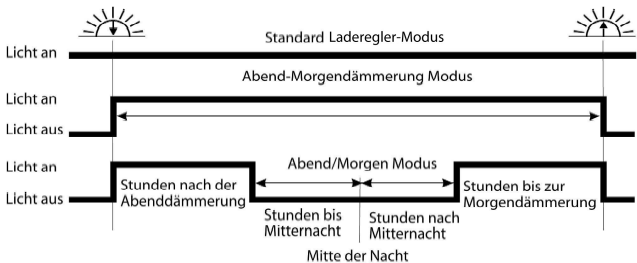

„Nachtmitte“ wird automatisch festgelegt als der Mittelpunkt zwischen Abend- und Morgendämmerung, das Stellen einer Uhr ist nicht erforderlich. Es kann einige Tage dauern bis der Laderegler präzise die Nachtmitte „gelernt“ hat. „Nachtmitte“ kann von 00:00 Mitternacht abweichen, abhängig von ihrem Standort.

Der Laderegler erkennt Tag und Nacht basierend auf der Leerlaufspannung der Solaranlage. Diese Tag-/Nacht-Schwelle kann den lokalen Lichtverhältnissen und der verwendeten Solaranlage angepasst werden.

Testfunktion

Das Drücken der „Test“ Taste an der Fernbedienung (CU) schaltet die Ladung am Lasteingang für eine Minute an.

Sollte das Drücken der Taste einen Lastabwurf (LVD Tiefentladungsschutz/SOC, Überstrom) verursachen, wird die Last sofort ausgeschaltet.

Sicherheitsfunktionen

	PV-Eingang	Batterie-Eingang	Last-Eingang
Verpolung	Geschützt (1)	Geschützt (1)	Geschützt (2)
Kurzschluss (3)	Geschützt	Geschützt (4)	Schaltet sich sofort aus
Überstrom	--	--	Schaltet sich mit Verzögerung aus(5)
Rückstrom	Geschützt (6)	--	--
Überspannung	Max. 30 V (7)	Max. 18 V	Schaltet sich über 15,5/31,0 V aus
Unterspannung	--	--	Schaltet sich aus
Übertemperatur	Reduziert den Ladestrom des PWM, wenn die Übertemperatur eintritt und schaltet die Last aus, wenn die Temperatur zu hoch wird.		

- (1) Panelspannung - Batteriespannung ist auf 60 V begrenzt.
- (2) Der Laderegler kann sich selbst schützen, aber Lasten können beschädigt werden.
- (3) Kurzschluss: $>3x - 20x$ Nennstrom.
- (4) Die Batterie muss mittels Sicherung geschützt werden, oder sie kann durch einen Kurzschluss dauerhaft geschädigt werden
- (5) $>200\%$ Nennstrom: Abschaltung nach 3 Sekunden Verzögerung,
 $>150\%$ Nennstrom: Abschaltung nach 10 Sekunden Verzögerung,
 $>110\%$ Nennstrom: Abschaltung nach 120 Sekunden Verzögerung.
- (6) Ein Rückstrom durch das Solarpanel wird durch einen Serien MOSFET verhindert. Diese Funktion wird ungefähr einmal in der Minute ± 5 Sekunden aktiviert und geprüft.
- (7) Die Spannung des Solarpanels sollte diese Grenze nicht für längere Zeit überschreiten, da der Spannungsschutz durch einen Varistor gewährleistet wird.

WARNUNG: Die Kombination von verschiedenen Fehlern kann einen Schaden am Laderegler verursachen. Bitte beheben Sie zuerst den Fehler bevor Sie mit dem Anschließen des Ladereglers fortfahren.

Tiefentladeschutz-Funktion (LVD)

- Ladezustandsgesteuert (SOC) : Abschaltung bei 11,00/22,00 V bis 11,70/23,40 V (SOC1); 11,12/22,24 V bis 11,76/23,52 V (SOC2), 11,25/22,50 V bis 11,83/23,63 V (SOC3); 11,38/22,72 V bis 11,89/23,78 V (SOC4), 11,51/23,02 V bis 11,96/23,92 V (SOC5); 11,64/23,28 V bis 12,02/24,04 V(SOC6).
- Spannungsgesteuert (LVD): Abschaltung bei einer bestimmten Spannung zwischen 11,0/22,0 V und 11,9/23,8 V (Schritt 0,1/0,2 V).

Anmerkung: Die Batteriespannung muss für mehr als 2 Minuten unter dem eingestellten Wert liegen, bevor der LVD auslöst.

Anmerkung: Die zwei Spannungsbereiche vor und nach dem Schrägstrich gelten in dieser Anleitung jeweils für 12 V und 24 V Systeme.

Werkseinstellungen

Sie können den CIS Laderegler mit der Fernbedienung (CU) einstellen.
Siehe CU Bedienungsanleitung für weitere Details.

	Werkseinstellungen
Last Modus	Standard Laderegler (Nachtlcht Aus)
Tiefentladeschutz	SOC4
Batterietyp	Gel
Nachtlcht-Status	8,0/16,0 V (1)
Last 1 Abendstunden	0 h
Last 1 Morgenstunden	0 h
Last 2 Abendstunden	0 h
Last 2 Morgenstunden	0 h

(1) hier handelt es sich um Leerlaufspannung, Tagesniveau = Nachtniveau +1,5/3,0 V

Nachtlicht-Schwelle/Schaltswelle

Der Laderegler erkennt Tag und Nacht basierend auf der Leerlaufspannung der Solaranlage. Diese Tag-/Nacht-Schwelle kann den lokalen Lichtverhältnissen und der verwendeten Solaranlage angepasst werden.

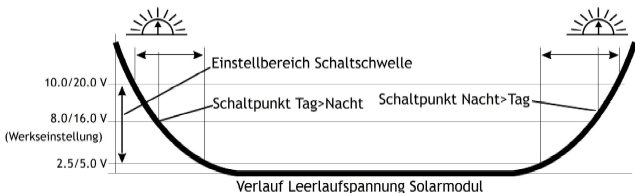

Um die richtigen Werte zu finden, messen Sie bitte die Leerlaufspannung an der Solaranlage in der Zeit wenn die Dämmerung den Wert erreicht hat und sich der Laderegler an bzw. ausschaltet. Dieser Wert (so genau wie möglich) kann dann entsprechend der Beschreibung im Programmierabschnitt eingestellt werden.

Anmerkung: Die zwei Spannungsbereiche vor und nach dem Schrägstrich gelten jeweils für 12 V und 24 V Systeme.

Technische Daten	CIS-N-05-2L	CIS-N-10-2L	CIS-N-20-2L
Systemspannung	12/24 V automatische Erkennung		
Max. Ladestrom	5 A**	10 A**	20 A**
Max. Ladestrom pro Strang	5 A**	10 A**	20 A**
Erhaltungsladung	13,8/27,6 V (25 °C)		
Hauptladung	14,4 V (25 °C), 0,5 h (täglich)		
Boost Ladung	14,4/28,8 V (25 °C), 2 h Aktivierung: Batteriespannung < 12,3/24,6 V		
Ausgleichsladung	14,8/29,6 V (25 °C), 2 h Aktivierung: Batteriespannung < 12,1/24,2 V (mindestens alle 30 Tage)		

Tiefentladeschutz Abschaltspannung	11,00-12,02/22,00-24,04 V bei SOC 11,0-11,9/22,0-23,8 V durch Spannung (einstellbarer Schritt 0,1/0,2V)
Wiedereinschaltspannung	12,8/25,6 V
Überspannungsschutz	15,5/31,0 V
Unterspannungsschutz	10,5/21,0 V
Max. Panel Spannung (Überspannungsschutz durch Varistor)	55 V
Max. Batteriespannung	40 V
Temperaturkompensation (Ladespannung)	-25/50 mV/K
Max. Eigenverbrauch	5 – 10 mA
Erdung	Negative Erdung
Umgebungstemperatur	-40 bis +60 °C
Max. Höhe	4.000 m ü. NN

Batterietyp	Blei (GEL, AGM, flüssig)
Einstellbereich: Abend Stunden Morgen Stunden Nachterkennung Tageserkennung	0 – 15 h 0 – 14 h 2,5 – 10,0 V / 5,0 – 20,0 V (Schrittweite 0,5/1,0 V) 4,0 – 11,5 V / 8,0 – 23,0 V (Schrittweite 0,5/1,0 V)
Kabellänge	10 cm
Abmessungen (BXHXT)	82x63x20 mm
Gewicht	150 g
Kabeldurchschnitt	AWG 13 (2.5 mm ²)
Schutzklasse	IP68 (1,5 m, 72 h)

** : Bei 60°C CIS kann nur vollen Strom auf Panel oder auf der Last haben, aber nicht auf beide gleichzeitig.

Haftungsausschluss

Der Hersteller haftet nicht für Schäden, insbesondere an der Batterie, die durch eine nicht wie vorgesehene oder wie im Handbuch beschriebene Verwendung entstehen, oder wenn die Empfehlungen des Batterieherstellers missachtet werden. Der Hersteller haftet nicht, wenn Reparaturen oder Kundendienst von nicht autorisierten Personen durchgeführt wurden, bei unsachgemäßem Gebrauch, falscher Installation oder falscher Systemauslegung.

Änderungen vorbehalten. Version: 20130730
Hergestellt in eine der folgenden Länder:
Germany - China - Bolivia - India
Phocos AG - Germany www.phocos.com

ISO9001



Please read the instructions carefully and thoroughly before using the product. It comes with a number of outstanding features, such as:

- Dual load
- Case protection: IP68 protection, in 1.5 m water depth 72 Hours
- Control unit (CU) to configure CIS-N-2L charge controller via infra-red data link
- External temperature sensor for temperature compensation of charge voltages
- 4 stage charging (main, boost, equalization, float) for flooded battery, 3 stage charging (main, boost, float) for sealed battery
- Automatic recognition of system voltage 12/24 V
- Widely programmable

IMPORTANT SAFETY INSTRUCTIONS



SAVE THESE INSTRUCTIONS

This manual contains important instructions for CIS-N-05-1.0, CIS-N-10-1.0, CIS-N-20-1.0, CIS-N-05-1.0-2L, CIS-N-10-1.0-2L, CIS-N-20-1.0-2L models that shall be followed during installation and maintenance of the charge controller.

INSTRUCTIONS DE SÉCURITÉS IMPORTANTES

CONSERVER CES INSTRUCTIONS

Cette notice contient d'importantes instructions visant les modèles CIS-N-05-1.0, CIS-N-10-1.0, CIS-N-20-1.0, CIS-N-05-1.0-2L, CIS-N-10-1.0-2L, CIS-N-20-1.0-2L, lesquelles doivent être suivies au moment de l'entretien de l'appareil.

If connection to the power lead or battery lead are accessible during operational maintenance the following warning shall be marked adjacent to the connection where practical or prominently displayed on the enclosure: **WARNING - EXPLOSION HAZARD - DO NOT DISCONNECT WHILE CIRCUIT IS LIVE UNLESS AREA IS KNOWN TO BE NON-HAZARDOUS.** and **AVERTISSEMENT - RISQUE D'EXPLOSION. NE PAS DÉBRANCHER TANT QUE LE CIRCUIT EST SOUS TENSION, À MOINS QU'IL NE S'AGISSE D'UN EMPLACEMENT NON DANGEREUX.**

EXPLOSION HAZARD. DO NO DISCONNECT WHILE THE CIRCUIT IS LIVE OR UNLESS THE AREA IS KNOWN TO BE FREE OF IGNITIBLE CONCENTRATIONS.

THIS EQUIPMENT IS SUITABLE FOR USE IN CLASS I, DIVISION 2, GROUPS A-D, T4A.



UL 1741 and



UL 1604, ANSI/ISA 12.12.01-2011, C22.2 No. 213-M1987.

RISK OF FIRE – MOUNT IN CONTACT WITH BATTERIES

Battery type: Lead acid, (GEL, AGM, flooded)

Nominal voltage rating of the battery: 12 or 24 V

Batteries fuse: use a fast acting fuse with a minimum of 1000A interrupting rating on the battery side. We recommend to use fast acting melting fuses (e.g. car type fuses) on the battery side, as close as possible at the battery terminal with 1.5 times the current rating of the maximum nominal current (see table).

Fuse ratings:

CIS-N type	CIS-N-05-2L	CIS-N-10-2L	CIS-N-20-2L
Fuse	15 A	30A	60 A

Please do not disassemble or attempt to repair Phocos products. Phocos charge controllers do not contain user serviceable parts.

Please observe all instructions with regards to external fuses/breakers as indicated.

Maintenance and installation notes

When installing or working on the PV system, please disconnect the PV (solar) modules from the charge controller first, to prevent any damages to the charge controller!

Please verify that all cable/wire connections are tightly fastened to the connectors/connecting posts in order to avoid any bad or loose connections that could result in excessive heating.

Please install a fuse or breaker near the battery before installing or adjusting the controller!

Please install and operate the controller in a dry environment.

High voltage risks

Operation of this device may produce a high voltage which could cause severe injuries or death in case of improper installation or operation of the device. PV modules can generate high DC voltages!

Make sure the cables are always connected to the correct terminal. An electrical shock can be lethal. In general, any electric shock can be dangerous to your health.

CE labeling

The product is CE compliant.

EN

Mounting of the unit

Since the charge controller must be able to sense the battery temperature it must be mounted into the same compartment together with the battery. It shall be mounted as close as possible to battery. We recommend not to use more than 1m wire length between battery and charge controller. This apparatus is suitable for use in Class I, Division 2 groups A, B, C, D or unclassified locations.

- Vertical mounting on non flammable surface with minimum 2 cm distance below and above unit.
- In case of higher ambient temperatures and limited heat dissipation (e.g. by surrounding compartment or smaller mounting distances), charge controller will limit its charge current to reduce temperature.
- If heat dissipation is limited by surrounding compartment, unit will limit charge current to reduce temperature.
- The charge controller is not intended to be installed within the wiring compartment of a PV module.
- The wiring methods in accordance with the National Electrical Code, ANSI/NFPA 70 are to be used.

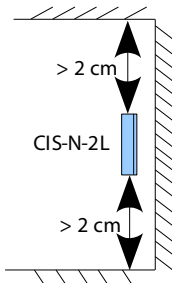

Connecting and Grounding

- Connect wires in order indicated 1, 2, 3, 4, 5, 6, 7, 8 to avoid installation faults
- To avoid any voltage on the wires, first connect the wire to the controller, then to the battery, panel or load
- Recommended minimum wire size: CIS-N-05: 2.5 mm²; CIS-N-10: 6.0 mm²; CIS-N-20: 10mm²
- Make sure the wire length between battery and controller is as short as possible
- Be aware that the negative terminal of CIS-N-2L are connected together and therefore

have the same electrical potential. If any grounding is required, always do this on the negative wires

- Connectors used in incandive circuits and incorporated within equipment shall be considered normally non-arcing if disconnection is not required under operational maintenance conditions, and if they are so secured that a separating force of at least 15 N is required for loosening.

	Function	Cable marker	Wire size (cross section)	color
①	Negative battery terminal	COMMON -	AWG 13 (2.5 mm ²)	Black
②	Positive battery terminal	BATTERY +	AWG 13 (2.5 mm ²)	Red
③	Negative panel terminal	COMMON -	AWG 13 (2.5 mm ²)	Black
④	Positive panel terminal	SOLAR +	AWG 13 (2.5 mm ²)	Yellow
⑤	Negative load1 terminal	COMMON -	AWG 13 (2.5 mm ²)	Black
⑥	Positive load1 terminal	LOAD 1 +	AWG 13 (2.5 mm ²)	Orange
⑦	Negative load2 terminal	COMMON -	AWG 13 (2.5 mm ²)	Black
⑧	Positive load2 terminal	LOAD 2 +	AWG 13 (2.5 mm ²)	Orange

CIS-N operational description

EN

The CIS-N charge controllers are built to be operated with 12V or 24V vented and sealed lead acid batteries. A series PWM-charge controller like the CIS-N connects the PV-panel to the battery, to charge it or disconnects it when the battery voltage is high enough. Depending on the battery voltage it will frequently switch ON and OFF the charge current to regulate the battery voltage. This voltage depends on the charge state (Main charge/ Boost/ Equalisation/ Float)

The CIS-N will disconnect the PV-panel from battery at night to prevent any current to flow back from the battery to the panel at night. These functions are achieved by the use of modern semiconductor switches, called power-MOS-FETs. one is used to switch on/off the charge current, the other one acts as actively switched diode to prevent back current from flowing from the battery backwards to the PV-panel at night. The CIS-N also provide one or two (-2L) power outputs to supply electronic loads with electricity. The output voltage of these load outputs is the battery voltage.

To protect the battery from getting deep discharged, the charge controller will disconnect the load output at a low SOC (state of charge). This level is adjustable. To protect connected load, the CIS-N will also disconnect the load at too high battery voltage levels. This function is also realized by a power-MOS-FET, one for each load output. To achieve temperature compensation of the charge voltage, the CIS-N have got an external temperature sensor to sense the ambient (battery) temperature. The charge controller will adapt the charge voltage according to this external temperature, to provide a charge voltage compensation of -4mV per degree Celsius and battery cell (24mV/K for a 12V battery, 48mV/K for a 24V battery).



To provide over-temperature protection functions, it has also a built in temperature sensor. If the internal temperature gets higher than about 75°C (e.g. at high charge currents and high ambient temperatures, the charge current will be decreased, to limit the internal power loss and thus to reduce internal heating. If the internal temperature is too high, it will also switch off the load current. This shall prevent the charge controller from being damaged by too high internal temperatures.

CIS-N units with one load output have got an additional DIM-output that provides a signal between 0 .. 10V to control the brightness of a lamp by use of a compatible LED driver. Widely adjustable settings can control the load output(s) and DIM output to provide various nightlight functions. These can be programmed/adjusted by use of the CU, an infrared remote control especially designed for the CIS-N series.

This all is realized by the use of a micro-controller inside the CIS-N. This micro controller is a small computer, equipped with software (firmware) and integrated peripherals to measure voltages, currents and digital signals, and output digital signal, to switch on and off transistors, controlling the FETs, LEDs, etc.

Display & Warning Functions

EN

LED	Status	Function
	On	Controller connected to battery, night detected
	Flash	Controller connected to battery, day detected
	Off	No battery connected
	On	Load 1 low/high voltage disconnect(LVD/HVD)
	Flash	Load 1 over current
	Off	Load 1 OK
	On	Load 2 low/high voltage disconnect(LVD/HVD)
	Flash	Load 2 over current
	Off	Load 2 OK
All LED	Green->Red->Green->	Programming

Night-Light Function

The CIS-N-2L controller comes with a sophisticated night-light function. It controls the load output at night and is widely programmable.

There are 3 modes available: Standard Controller, Dusk to Dawn and Evening/Morning modes.

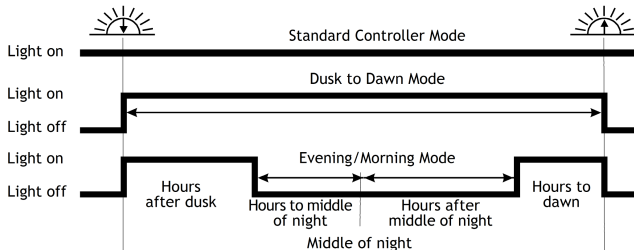

"Middle of night" is detected automatically as the midpoint between dusk and dawn, no setting of a clock is required. It may take several days until the controller has "learned" the middle of the night precisely. "Middle of night" may be different from 12:00 midnight depending on your location.

The controller recognizes day and night based on the solar array open circuit voltage.

This day/night threshold can be modified according to local light conditions and the solar array used.

EN

Testing Function

By pushing the "Test Button" on the CU (Control Unit), the Load terminal will be switched "on" for 1 minute. If pressing the button causes a load disconnect event (LVD/SOC, over current) the load will be switched off immediately.

Safety Features

	PV terminal	Battery terminal	Load terminal
Reverse polarity	Protected (1)	Protected (1)	Protected (2)
Short circuit(3)	Protected (8)	Protected (4)	Switches off immediately(8)
Over current	N/A	N/A	Switches off with delay(5)
Reverse current	Protected(6)	N/A	N/A
Over voltage	Max. 55 V (7)	Max. 40 V	Switches off above 15.5/31.0 V
Under voltage	N/A	N/A	Switches off
Over temp.	Reduces the charging current by PWM if over temperature occurs and switches off the load if the temperature reaches a high level.		

(1) Upanel-Ubattery is limited to 60V.

- (2) Controller can protect itself, but loads might be damaged.
- (3) Short circuit: $>3x - 20x$ nominal current.
- (4) Battery must be protected by a fuse, or it can be permanently damaged in case of a short circuit.
- (5) $>200\%$ nominal current: disconnect with 3s delay,
 $>150\%$ nominal current: disconnect with 10s delay,
 $>110\%$ nominal current: disconnect with 120s delay.
- (6) Reverse current through solar panel is blocked by serial MOSFET. This function is tested and activated approx. once in 1min +/-5s.
- (7) The solar panel voltage should not exceed this limit for a long time as voltage protection is done by a varistor.
- (8) Limited electronic protection; must be additionally protected by an external fast acting fuse against short circuit to prevent damage from charge controller; nominal fuse rating shall be 1.5 times the maximum charge current.

WARNING: The combination of different error conditions may cause damage to the controller. Always remove the error before you continue connecting the controller!

Low Voltage Disconnect Function (LVD)

- State of charge (SOC) controlled: Disconnect at
11.00/22.00 V to 11.70/23.40 V(SOC1), 11.12/22.24 V to 11.76/23.52 V(SOC2),
11.25/22.50 V to 11.83/23.63 V(SOC3), 11.38/22.72 V to 11.89/23.78 V(SOC4),
11.51/23.02 V to 11.96/23.92 V(SOC5), 11.64/23.28 V to 12.02/24.04 V(SOC6).
- Voltage controlled (LVD): Disconnect at a fixed voltage between 11.0/22.0 V and 11.9/23.8 V

(Step 0.1/0.2 V).

Note: Battery voltage must be below setting for longer than 2 minutes for LVD to take effect.

Note: The two voltage levels before/after the slash are valid for 12 V and 24 V systems respectively (valid for the charge controllers in this manual).

Factory Settings

You can configure CIS-N-2L charge controllers via the Control Unit (CU). See CU manual for details.

	Factory setting
Load mode	Standard controller(night light off)
Low voltage disconnect	SOC4
Battery type	Gel
Night light level	8.0/16.0 V (1)
Load 1 evening hours	0 h
Load 1 morning hours	0 h
Load 2 evening hours	0 h
Load 2 morning hours	0 h

(1) PV panel open circuit voltage: Day level = Night level + 1.5/3.0 V

Night light level

The controller recognizes "day" and "night" based on the solar PV array open circuit voltage. The daylight threshold can be modified according to the requirements of the local conditions and the solar PV array used.

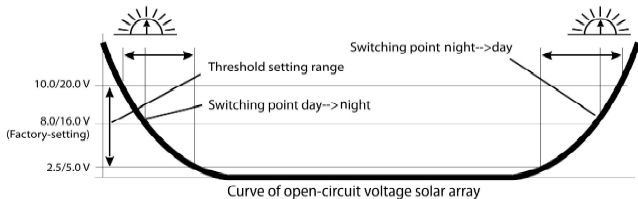

To find the correct values, we recommend measuring the PV solar array open circuit voltage at the time when twilight has reached the level when the controller should switch the loads "on" or "off". This value (the closest available) can then be set according to the description in the programming section.

Technical Data

EN

Note: The two voltage levels before/after the slash are valid for 12 V and 24 V systems respectively.

Technical Data	CIS-N-05-2L	CIS-N-10-2L	CIS-N-20-2L
System voltage	12/24 V auto recognition		
Max. charge current	5 A**	10 A**	20 A**
Max. load current per string	5 A**	10 A**	20 A**
Float charge	13.8/27.6 V(25 °C)		
Main charge	14.4 V (25 °C), 0.5 h (daily)		
Boost charge	14.4/28.8 V (25 °C), 2 h activation: battery voltage < 12.3/24.6 V		
Equalization	14.8/29.6 V (25 °C), 2 h activation: battery voltage < 12.1/24.2 V (at least every 30 days)		
Deep discharge protection Cut-off voltage	11.00-12.02/22.00-24.04 V By SOC 11.0-11.9/22.0-23.8 V By voltage (adjustable step 0.1/0.2V)		
Reconnect level	12.8/25.6 V		

Overvoltage protection	15.5/31.0 V
Under voltage protection	10.5/21.0 V
Maximum solar voltage	30 V/50V (12/24 V system voltage)
Max. battery voltage	40 V
Temperature compensation (Charge voltage)	-25/50 mV/K
Max. self-consumption	5 – 10 mA
Grounding	Negative grounding
Ambient temperature range	-40 to +60 °C**
Maximum operational ambient temperature	50°C
Max. altitude	4,000 m above sea level
Battery type	lead acid (GEL, AGM, flooded)
Adjustment range: Evening hours Morning hours Night detection Day detection	0 – 15 h 0 – 14 h 2.5 – 10.0 V / 5.0 – 20.0 V (adjust step 0.5/1.0 V) 4.0 – 11.5 V / 8.0 – 23.0 V (adjust step 0.5/1.0 V)

Wire length	10 cm
Dimensions(WXHXD)	82x63x20 mm
Weight	150 g
Wire cross section	AWG 13 (2.5 mm ²)
Type of protection	IP68 (1.5 m, 72 h)

** : At an ambient temperature above 50°C, with all currents applied, the charge controller will automatically reduce the charge current to limit the internal temperature.

Liability Exclusion

The manufacturer shall not be liable for damages, especially on the battery, caused by use other than as intended or as mentioned in this manual or if the recommendations of the battery manufacturer are neglected. The manufacturer shall not be liable if there has been service or repair carried out by any unauthorized person, unusual use, wrong installation, or bad system design.

Subject to change without notice. Version: 20130730
 Made in one of the following countries:
 Germany - China - Bolivia - India
 Phocos AG - Germany www.phocos.com

ISO9001

 RoHS

Lea las instrucciones detenidamente y con mucha atención antes de utilizar el producto. Cuenta con varias características extraordinarias, tales como:

- Puesta a tierra negativa
- Carga doble
- Protección de la carcasa: protección IP68, en 1,5 m de profundidad de agua durante 72 horas
- Unidad de control (CU) para configurar el controlador de carga CIS-N-2L por medio de enlace de datos infrarrojo
- Sensor de temperatura exterior para compensación de temperatura de los voltajes de carga
- 4 fases de carga para baterías con electrolito líquido (principal, rápida, de compensación, de flotación), 3 fases de carga para baterías selladas (principal, rápida, de flotación)
- Reconocimiento automático del voltaje del sistema de 12/24 V
- Ampliamente programable

Conexión y puesta a tierra

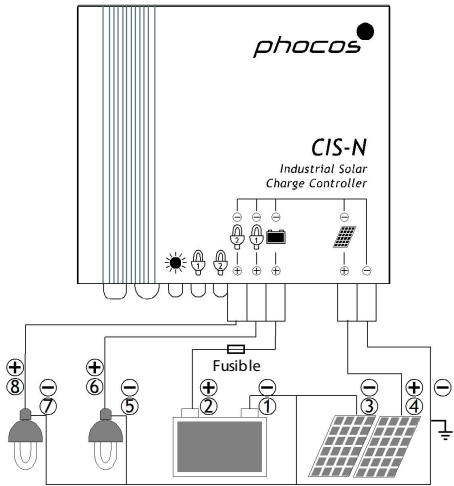

- Conecte los cables en el orden indicado 1 2 3 4 5 6 7 8 para evitar fallas de la instalación
- Para evitar el voltaje en los cables, primero conecte el cable al controlador, luego a la batería, panel o carga
- Sección mínima recomendada para los cables: CIS05: 2,5 mm²; CIS10: 6,0 mm²; CIS20: 10 mm²
- Asegúrese de que el cable entre la batería y el controlador sea lo más corto posible
- Tenga presente que los terminales negativos de CIS-N-2L se conectan juntos y por lo tanto tienen el mismo potencial eléctrico. Si se necesita una puesta a tierra, debe ser siempre en los cables negativos

	Función	Marcado del cable	Tamaño del cable (sección)	Color
①	Terminal negativo de la batería	COMMON -	AWG 13 (2.5 mm ²)	negro
②	Terminal positivo de la batería	BATTERY +	AWG 13 (2.5 mm ²)	rojo
③	Terminal negativo del módulo	COMMON -	AWG 13 (2.5 mm ²)	negro
④	Terminal positivo del módulo	SOLAR +	AWG 13 (2.5 mm ²)	amarillo
⑤	Terminal negativo de carga 1	COMMON -	AWG 13 (2.5 mm ²)	negro
⑥	Terminal positivo de carga 1	LOAD 1 +	AWG 13 (2.5 mm ²)	naranja
⑦	Terminal negativo de carga 2	COMMON -	AWG 13 (2.5 mm ²)	negro
⑧	Terminal positivo de carga 2	LOAD 2 +	AWG 13 (2.5 mm ²)	naranja



Funciones de visualización y advertencia

ES

LED	Estado	Función
	Encendido	Controlador conectado a la batería, detección nocturna
	Destello	Controlador conectado a la batería, detección diurna
	Apagado	Sin conexión a batería
	Encendido	Desconexión de carga 1 por voltaje alto/bajo (LVD/HVD)
	Destello	Exceso de corriente de carga 1
	Apagado	Carga 1 correcta
	Encendido	Desconexión de carga 2 por voltaje alto/bajo (LVD/HVD)
	Destello	Exceso de corriente de carga 2
	Apagado	Carga 2 correcta
Todos los LED	Verde->Rojo->Verde->	Programación

Función de luz nocturna

El controlador CIS-N-2L cuenta con una sofisticada función de luz nocturna. Controla la salida de carga nocturna y es ampliamente programable.

Hay tres modos disponibles: controlador estándar, modo crepúsculo hasta el amanecer y modo tarde/mañana.

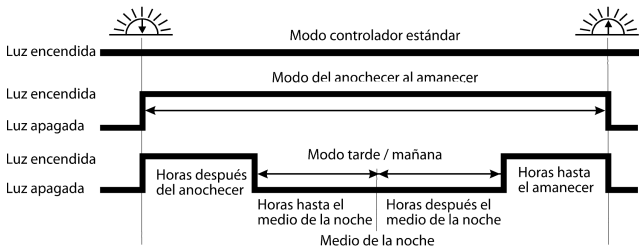

"Mitad de la noche" se detecta automáticamente como punto medio entre el crepúsculo y el amanecer, no se requiere configurar un reloj. Puede llevar varios días hasta que el controlador "aprenda" la mitad de la noche con precisión. "Mitad de la noche" puede ser un valor diferente de las 00:00 de la medianoche, dependiendo de su ubicación.

El controlador reconoce el día y la noche sobre la base del voltaje de circuito abierto del módulo solar.

El umbral día/noche se puede modificar de acuerdo a las condiciones locales y al módulo solar utilizado.

ES

Función de prueba

Al presionar el "Botón de prueba" en la CU (unidad de control), se enciende el terminal de carga durante 1 minuto.

Si al presionar el botón se genera un evento de desconexión de carga (LVD/SOC, exceso de corriente) se desconecta la carga en forma inmediata.

Funciones de seguridad

	Terminal panel	Terminal de batería	Terminal de carga
Polaridad inversa	Protegido (1)	Protegido (1)	Protegido (2)
Cortocircuito (3)	Protegido	Protegido (4)	Se apaga inmediatamente
Sobrecorriente	No Disponible	No Disponible	Se apaga con retardo (5)
Corriente inversa	Protegido (6)	No Disponible	No Disponible
Sobre voltaje	Máx. 55 V (7)	Máx. 40 V	Se apaga por encima de 15,5/31,0 V
Bajo voltaje	No Disponible	No Disponible	Se apaga
Exceso de temp.	Reduce la corriente de carga por PWM si se produce un exceso de temperatura y apaga la carga si la temperatura alcanza un nivel alto.		

- (1) Panel U-Batería U se limita a 60 V.
- (2) El controlador se protege a sí mismo pero se pueden dañar las cargas.
- (3) Cortocircuito: $>3x - 20x$ de la corriente nominal.
- (4) La batería debe estar protegida por un fusible, de lo contrario puede dañarse en forma permanente en caso de corto circuito.
- (5) $>200\%$ de la corriente nominal: desconexión con 3 s de retardo,
 $>150\%$ de la corriente nominal: desconexión con 10 s de retardo,
 $>110\%$ de la corriente nominal: desconexión con 120 s de retardo

- (6) Corriente inversa a través del panel solar bloqueada por MOSFET serial. Esta función se prueba y se activa aprox. una vez cada 1 min +/-5 s.
- (7) El voltaje del panel solar no debe exceder este límite por mucho tiempo, dado que está protegido por un varistor.

ES

ADVERTENCIA: la combinación de diversas situaciones de error puede dañar el controlador. ¡Corrija siempre el error antes de continuar la conexión del controlador!

Función de desconexión por bajo voltaje (LVD)

- Controlado por estado de carga (SOC): desconexión a 11,00/22,00 V a 11,70/23,40 V (SOC1), 11,12/22,24 V a 11,76/23,52 V (SOC2), 11,25/22,50 V a 11,83/23,63 V (SOC3), 11,38/22,72 V a 11,89/23,78 V (SOC4), 11,51/23,02 V a 11,96/23,92 V (SOC5), 11,64/23,28 V a 12,02/24,04 V (SOC6).
- Controlado por voltaje (LVD): desconexión en voltaje fijo entre 11,0/22,0 V y 11,9/23,8 V (paso 0,1/0,2 V).

Nota: el voltaje de la batería debe estar por debajo de lo establecido durante más de 2 minutos, para que se haga efectiva la LVD.

Nota: los dos niveles de voltaje antes/después de la barra son válidos para los sistemas de 12 V y 24 V respectivamente (válidos para los controladores de carga de este manual).

Configuración de fábrica

Puede configurar los controladores de carga CIS-N-2L por medio de la unidad de control (CU). Consulte los detalles en el manual de la CU.

ES

	Configuración de fábrica
Modo de carga	Controlador estándar (luz nocturna apagada)
Desconexión por bajo voltaje	SOC4
Tipo de batería	Gel
Nivel de luz nocturna	8,0/16,0 V (1)
Carga 1 de horas de la tarde	0 h
Carga 1 de horas de la mañana	0 h
Carga 2 de horas de la tarde	0 h
Carga 2 de horas de la mañana	0 h

(1) Voltaje de circuito abierto del panel PV: nivel diurno = nivel nocturno +1,5/3,0 V

Nivel de luz nocturna

El controlador reconoce "día" y "noche" sobre la base del voltaje de circuito abierto del módulo solar fotovoltaico. El umbral de luz de día se puede modificar de acuerdo a los requisitos de las condiciones locales y al módulo solar fotovoltaico utilizado.

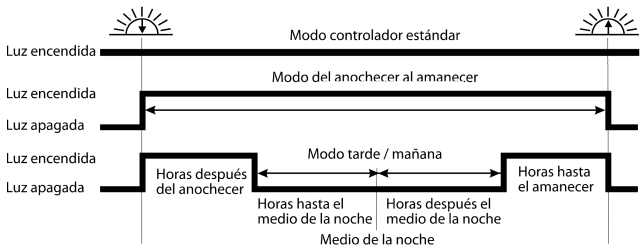

Para encontrar los valores correctos, recomendamos medir el voltaje de circuito abierto del módulo solar fotovoltaico en el momento del crepúsculo cuando se alcanza el nivel en el que el controlador debe "encender" o "apagar" la carga. Este valor (el más cercano disponible) puede ser establecido entonces de acuerdo a la descripción de la sección de programación.

Datos técnicos

Nota: los dos niveles de voltaje antes/después de la barra son válidos para los sistemas de 12 V y 24 V respectivamente.

Datos técnicos	CIS-N-05-2L	CIS-N-10-2L	CIS-N-20-2L
Tensión del sistema	12/24 V reconocimiento automático		
Máx. corriente de carga	5 A**	10 A**	20 A**
Máx. corriente de carga por cadena	5 A**	10 A**	20 A**
Carga de flotación	13,8/27,6 V (25 °C)		
Carga principal	14,4 V (25 °C), 0,5 h (diarias)		
Carga rápida	14,4/28,8 V (25 °C), 2 h activación: voltaje de la batería <12,3/24,6 V		
Ecuilibración	14,8/29,6 V (25 °C), 2 h activación: voltaje de la batería <12,1/24,2 V (al menos cada 30 días)		
Protección contra descarga total: Tensión de desconexión	11,00-12,02/22,00-24,04 V por SOC 11,0-11,9/22,0-23,8 V por voltaje (Paso ajustable 0,1/0,2 V)		

Tensión de reconexión	12,8/25,6 V
Protección de sobrevoltaje	15,5/31,0 V
Protección contra bajo voltaje	10,5/21,0 V
Voltaje máx. del panel (Protección de sobrevoltaje con varistor)	55 V
Máx. voltaje de la batería	40 V
Compensación de temperatura (Voltaje de carga)	-25/50 mV/K
Máx. autoconsumo	5 – 10 mA
Puesta a tierra	Puesta a tierra negativa
Temperatura ambiente	-40 a +60 °C
Altitud máx.	4.000 m sobre el nivel del mar
Tipo de batería	plomo-ácido (GEL, AGM, electrolito líquido)
Rango de ajuste: horas de la tarde Horas de la mañana detección de noche Detección de día	0 – 15 h 0 – 14 h 2,5 – 10,0 V / 5,0 – 20,0 V (paso de ajuste 0,5/1,0 V) 4,0 – 11,5 V / 8,0 – 23,0 V (paso de ajuste 0,5/1,0 V)

Largo del cable	10 cm
Dimensiones (An x Al X Pr)	82 x 63 x 20 mm
Peso	150 g
Sección del cable	AWG 13 (2.5 mm ²)
Tipo de protección	IP68 (1,5 m; 72 h)

** : A 60 °C CIS puede tener solo corriente completa en panel o carga, pero no ambas simultáneamente.

Exclusión de responsabilidad

El fabricante no será responsable por los daños, especialmente a la batería, provocados por un uso diferente del previsto o mencionado en este manual, ni por la falta de cumplimiento de las recomendaciones del fabricante de la batería. El fabricante no será responsable en caso de reparaciones o servicios realizados por parte de personas no autorizadas, uso inadecuado, instalación incorrecta o mal diseño del sistema.

Sujeto a cambios sin aviso. Versión: 20130730
Fabricado en uno de los siguientes países:
Alemania - China - Bolivia - India
Phocos AG - Alemania www.phocos.com

ISO9001

 RoHS

Veillez lire attentivement l'ensemble de ces instructions avant d'utiliser ce produit. Il est doté de caractéristiques exceptionnelles telles que:

- Mise à la terre négative
- Double charge
- Protection boîtier: protection IP68, résistant à 1,5 m de profondeur dans l'eau pendant 72 heures
- Unité de commande (CU) servant à configurer le régulateur de charge CIS-N-2L via un échange de données infrarouge
- Détecteur externe de température pour compenser les températures des tensions de charge
- 4 modes de recharge (tension principale, de boostage, flottante d'égalisation) pour batteries liquides, 3 modes de recharge (tension principale, de boostage, flottante) pour batteries GEL
- Reconnaissance automatique de la tension de l'appareil 12/24 V
- Intégralement programmable

Raccordement et mise à la terre

- Connectez les fils dans l'ordre indiqué (1 2 3 4 5 6 7 8) afin d'éviter des erreurs d'installation.
- Afin d'éviter toute tension au niveau des fils, veuillez tout d'abord connecter le fil au régulateur, puis à la batterie, au panneau solaire ou à la charge
- Calibre minimum du fil (recommandé): CIS05: 2,5 mm²; CIS10: 6,0 mm²; CIS20: 10 mm²
- Assurez-vous que la longueur du fil reliant la batterie au régulateur est la plus courte possible

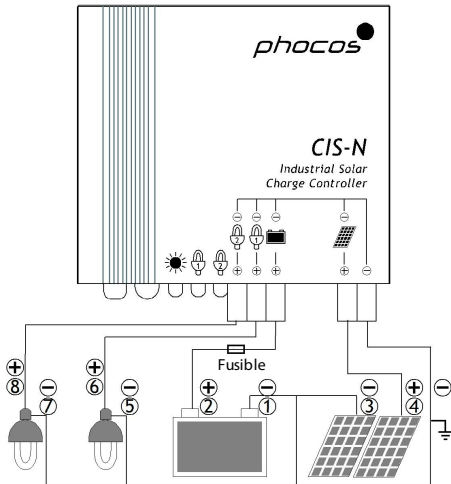

- Assurez-vous que les bornes négatives du CIS-N-2L sont connectées ensemble et qu'elles ont donc le même potentiel électrique. Si une mise à la terre est nécessaire, veillez à le faire avec les fils négatifs

	Fonction	Marquage du câble	Taille du câble (section transversale)	Couleur
①	Borne négative de la batterie	COMMON -	AWG 13 (2.5 mm ²)	noir
②	Borne positive de la batterie	BATTERY +	AWG 13 (2.5 mm ²)	rouge
③	Borne négative du panneau solaire	COMMON -	AWG 13 (2.5 mm ²)	noir
④	Borne positive du panneau solaire	SOLAR +	AWG 13 (2.5 mm ²)	jaune
⑤	Borne négative de la charge 1	COMMON -	AWG 13 (2.5 mm ²)	noir
⑥	Borne positive de la charge 1	LOAD 1 +	AWG 13 (2.5 mm ²)	orange
⑦	Borne négative de la charge 2	COMMON -	AWG 13 (2.5 mm ²)	noir
⑧	Borne positive de la charge 2	LOAD 2 +	AWG 13 (2.5 mm ²)	orange



Symboles d'affichage et fonctions d'avertissement

FR

LED	État	Fonction
	Marche	Régulateur connecté à la batterie, détection de nuit
	Clignote	Régulateur connecté à la batterie, détection de jour
	Arrêt	Batterie non connectée
	Marche	Charge 1 protection de décharge profonde / de surtension (LVD/HVD)
	Clignote	Charge 1 surintensité de charge
	Arrêt	Charge 1 OK
	Marche	Charge 2 protection de décharge profonde / de surtension (LVD/HVD)
	Clignote	Charge 2 surintensité de charge
	Arrêt	Charge 2 OK
Toutes les LED	Vertes > Rouges > Vertes	Programmation en cours

Fonction jour/nuit

Le régulateur CIS-N-2L est équipé d'une fonction avancée jour/nuit qui commande la charge pendant la nuit et est intégralement programmable.

Il existe 3 modes différents: Standard, du crépuscule à l'aube et soirée/matin.

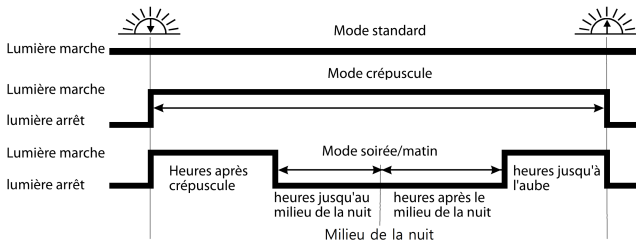

FR

Le "milieu de la nuit" est automatiquement identifié comme point central entre le crépuscule et l'aube, aucune configuration n'est requise. Plusieurs jours peuvent être nécessaires avant que le régulateur "apprenne" à reconnaître le milieu de la nuit avec précision. Le "milieu de la nuit" peut, en fonction de votre lieu d'habitation, être différent de 00:00.

Le régulateur différencie le jour de la nuit grâce à la tension à vide du générateur solaire. Le seuil jour/nuit peut être modifié selon vos conditions d'ensoleillement locales et le générateur solaire utilisé.

Fonction test

FR

En appuyant sur la touche «test» de l'unité de commande, vous mettez sous tension la borne de charge pendant 1 minute. Si en appuyant sur la touche vous déclenchez un délestage (LVD/SOC, surintensité), la charge est immédiatement mise hors tension.

Caractéristiques de sécurité

	Borne panneau	Borne batterie	Borne charge
Polarité inversée	Protégée (1)	Protégée (1)	Protégée (2)
Court-circuit (3)	Protégée	Protégée (4)	S'éteint immédiatement
Surintensité	Non disponible	Non disponible	S'éteint avec retard (5)
Courant inversé	Protégée (6)	Non disponible	Non disponible
Surtension	55 V max. (7)	40 V max.	S'éteint au-delà de 15,5/31,0 V
Sous-tension	Non disponible	Non disponible	S'éteint
Surtempérature	Réduit le courant de charge à PWM en cas de surtempérature et coupe la charge si la température atteint un niveau trop élevé		

- (1) La tension de la batterie du module est limitée à 60 V.
- (2) Le régulateur peut assurer sa propre protection, mais il est possible que les charges soient endommagées.
- (3) Court-circuit: $>3x - 20x$ courant nominal.
- (4) La batterie doit être protégée par un fusible sinon elle sera endommagée irrémédiablement en cas de court-circuit.
- (5) $>200\%$ courant nominal: déconnexion au bout de 3 s,
 $>150\%$ courant nominal: déconnexion au bout de 10 s,
 $>110\%$ courant nominal: déconnexion au bout de 120 s.
- (6) Le courant inversé qui traverse le panneau solaire est bloqué par MOSFET de série. Cette fonction est testée et activée environ une fois par minute +/- 5 s.
- (7) La tension du panneau solaire ne doit pas dépasser la limite autorisée pendant une durée trop longue car c'est une varistance qui assure sa protection contre les surtensions.

AVERTISSEMENT : Le régulateur peut se détériorer si différents cas de dysfonctionnement surviennent simultanément. Réglez toujours le problème en cours avant de continuer à utiliser le régulateur!

Fonction de protection contre les décharges profondes (LVD)

- Commande de l'état de charge (SOC): Déconnecté à 11,00/22,00 V à 11,70/23,40 V(SOC1); 11,12/22,24 V à 11,76/23,52 V(SOC2); 11,25/22,50 V à 11,83/23,63 V(SOC3); 11,38/22,72 V à 11,89/23,78 V(SOC4); 11,51/23,02 V à 11,96/23,92 V(SOC5); 11,64/23,28 V à 12,02/24,04 V(SOC6).
- Déclenchement de la tension (LVD): Déconnecté à une tension fixe comprise entre 11,00/22,00 V et 11,9/23,8 V (par paliers de 0,1/0,2 V).

Remarque: Si la tension de la batterie est plus basse que la position de réglage pendant plus de 2 minutes, la tension se déclenche.

Remarque: Les deux niveaux de tension se trouvant avant et après la barre oblique sont respectivement valables pour les systèmes 12 V et 24 V (valable pour les régulateurs de charge de ce manuel).

Paramètres d'usine (par défaut)

Vous pouvez configurer les régulateurs CIS-N-2L via l'unité de commande. Consultez le manuel de l'unité de commande pour plus de détails.

	Paramètres d'usine (par défaut)
Mode de charge	Régulateur standard (fonction jour/nuit arrêtée)
Protection décharge profonde	SOC4
Type de batterie	Gel
Statut niveau jour/nuit	8,0/16,0 V (1)
Charge 1 soirée	0 h
Charge 1 matin	0 h
Charge 2 soirée	0 h
Charge 2 matin	0 h

(1) Si le panneau solaire est sous tension à vide, le niveau du jour = niveau de la nuit + 1,5/3,0 V

Niveau jour/nuit

Le régulateur différencie le jour de la nuit grâce à la tension à vide du générateur solaire.
Le seuil jour/nuit peut être modifié selon les nécessités de vos conditions locales et le générateur solaire utilisé.

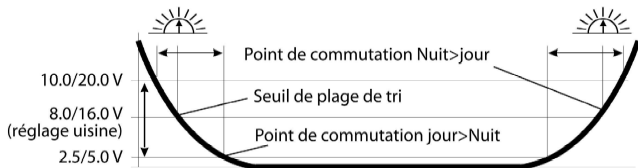

Courbe de tension en circuit ouvert du générateur solaire

Afin de trouver les valeurs correctes, nous vous recommandons de mesurer la tension à vide du générateur solaire au moment où le crépuscule a atteint le niveau auquel le régulateur doit « allumer » ou « éteindre » les charges. Cette valeur (la plus proche possible) peut alors être programmée selon la description de la partie programmation.

Caractéristiques techniques

Note : Les deux niveaux de tensions précédant/suivant la barre oblique sont valables pour les systèmes 12 V et 24 V respectivement.

Caractéristiques techniques	CIS-N-05-2L	CIS-N-10-2L	CIS-N-20-2L
Tension de système	Reconnaissance automatique 12/24 V		
Courant max. de charge	5 A**	10 A**	20 A**
Courant max. de chargement par série	5 A**	10 A**	20 A**
Charge d'entretien	13,8/27,6 V (25 °C)		
Charge principale	14,4 V (25 °C), 0,5 h (quotidiennement)		
Charge de boostage	14,4/28,8 V (25 °C), 2 h Activation: Tension de la batterie < 12,3/24,6 V		
Égalisation	14,8/29,6 V (25 °C), 2 h Activation: Tension de la batterie < 12,1/24,2 V (au moins tous les 30 jours)		
Protection de décharge profonde Tension de coupure	11,00-12,02/22,00-24,04 V, état de charge 11,0-11,9/22,0-23,8 V, tension (par paliers de 0,1/0,2 V)		
Niveau de reconnexion	12,8/25,6 V		

Protection surtension	15,5/31,0 V
Protection sous-tension	10,5/21,0 V
Tension max. panneau solaire (protection surtension par varistance)	55 V
Tension max. batterie	40 V
Compensation thermique (tension de charge)	-25/50 mV/K
Autoconsommation max.	5 – 10 mA
Mise à la terre	Négative (mise à la terre)
Température ambiante	-40 à +60 °C
Altitude max.	4.000 m au-dessus du niveau de la mer
Type de batterie	Plomb-acide (GEL, AGM, liquide)
Gamme de réglage: Heures de soirée Heures de matinée Détection nuit Détection jour	0 – 15 h 0 – 14 h 2,5 – 10,0 V / 5,0 – 20,0 V (par paliers 0,5/1,0 V) 4,0 – 11,5 V / 8,0 – 23,0 V (par paliers 0,5/1,0 V)
Longueur des fils	10 cm
Dimensions (L x h x l)	82 x 63 x 20 mm

Poids	150 g
Section transversale des fils	AWG 13 (2.5 mm ²)
Type de protection	IP68 (1,5 m, 72 h)

** : À 60°C, le régulateur CIS peut soit traiter le courant max. du panneau solaire, soit le courant max. de la charge, mais pas les deux simultanément.

FR

Clause de non-responsabilité

Le fabricant ne pourra être tenu responsable des dommages, plus particulièrement concernant la batterie, résultant d'une utilisation autre que celle pour laquelle l'appareil est prévu, telle qu'elle est décrite ou mentionnée dans ce mode d'emploi, ou si les recommandations du fabricant de la batterie ne sont pas respectées. Le fabricant ne pourra être tenu responsable en cas de maintenance ou de réparation réalisée par toute personne non habilitée, d'utilisation inappropriée, d'installation incorrect ou d'une mauvaise conception du système.

Susceptible d'être modifié sans préavis. Version : 20130730

Fabriqué dans l'un des pays suivants :

Allemagne - Chine - Bolivie - Inde

Phocos AG – Allemagne

www.phocos.com

ISO9001

Por gentileza, leia com atenção todas as instruções antes de usar o produto. Ele possui uma série de recursos exclusivos, tais como:

- Aterramento negativo
- Saída dupla
- Proteção do involuço: proteção IP68, em profundidade de água de 1,5m por 72 horas
- Unidade de controle (UC) para configurar o controlador de carga CIS-N-2L via "link" de dados por infra-vermelho
- Sensor de temperatura externa para compensação em temperatura das tensões de carga
- Carga em 4 etapas (principal, rápida, flutuação, equalização) para baterias não-seladas, e de 3 etapas (principal, rápida, flutuação) para baterias seladas
- Reconhecimento automático da tensão do sistema 12/24 V
- Várias opções de programação

Conexão e Aterramento



- Conecte os condutores na ordem indicada 1 2 3 4 5 6 7 8 para evitar falhas na instalação.
- Para evitar qualquer tensão nos condutores, conecte primeiro o condutor ao controlador, depois à bateria, painel e carga.
- Bitola mínima recomendada para a fiação: CIS05: 2,5 mm²; CIS10: 6,0 mm²; CIS20: 10 mm²
- Certifique-se de que o comprimento do condutor entre a bateria e o controlador seja o menor possível
- Esteja ciente de que os terminais negativos do CIS-N-2L estão conectados conjuntamente

e, portanto, têm o mesmo potencial elétrico. Caso um aterramento seja necessário, faça-o sempre nos condutores negativos

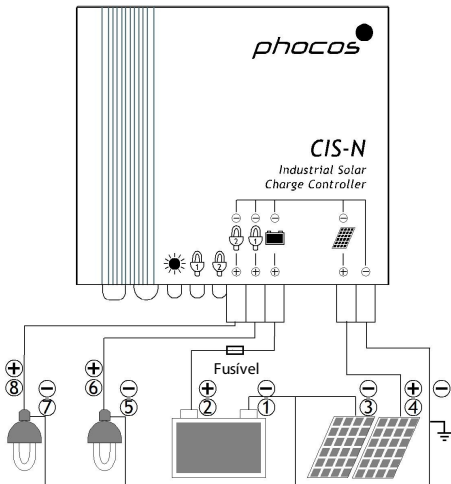
	Função	Maucação tubo retrátil	Diametro/seção	Cor
①	Terminal negativo da bateria	COMMON -	AWG 13 (2.5 mm ²)	preto
②	Terminal positivo da bateria	BATTERY +	AWG 13 (2.5 mm ²)	vermelho
③	Terminal negativo do painel	COMMON -	AWG 13 (2.5 mm ²)	preto
④	Terminal positivo do painel	SOLAR +	AWG 13 (2.5 mm ²)	amarelo
⑤	Terminal negativo 1 da carga	COMMON -	AWG 13 (2.5 mm ²)	preto
⑥	Terminal positivo 1 da carga	LOAD 1 +	AWG 13 (2.5 mm ²)	laranja
⑦	Terminal negativo 2 da carga	COMMON -	AWG 13 (2.5 mm ²)	preto
⑧	Terminal positivo 2 da carga	LOAD 2 +	AWG 13 (2.5 mm ²)	laranja



Funções de Visualização e Advertência

LED	Estado	Função
	Ligado	Controlador conectado à bateria, noite detectada
	Luz intermitente	Controlador conectado à bateria, dia detectado
	Desligado	Nenhuma bateria conectada
	Ligado	Carga 1 protegida contra baixa/alta tensão (LVD/HVD)
	Luz intermitente	Carga 1 sobrecarga
	Desligado	Carga 1 OK
	Ligado	Carga 2 protegida contra baixa/alta tensão(LVD/HVD)
	Luz intermitente	Carga 2 sobrecarga
	Desligado	Carga 2 OK
Todos os LED	Verde->Vermelho->Verde->	Programação

Função de luz Noturna

O controlador CIS-N-2L vem com uma sofisticada função de luz noturna. Esta controla a saída de carga à noite e possui várias opções de programação.

Existem três modos disponíveis: Modo controlador padrão, modo anoitecer até o amanhecer e modo noturno/matinal.

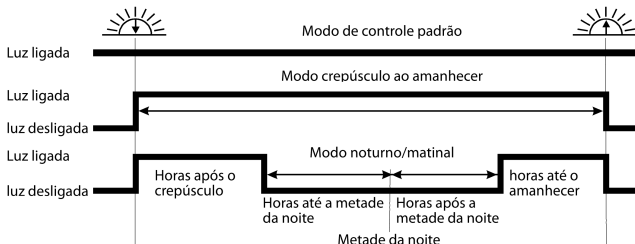

O "meio da noite" é detectado automaticamente como o ponto médio entre o anoitecer e o amanhecer, não sendo necessário um ajuste de relógio. O controlador poderá levar alguns dias até que "aprenda" a detectar com precisão o meio da noite. O "meio da noite" pode não ser à meia-noite, dependendo de sua localização.

O controlador reconhece o dia e a noite baseado na tensão de circuito aberto do painel solar. Este ponto inicial entre dia e noite pode ser ajustado de acordo com as condições locais de luminosidade e o painel solar utilizado.

Função de Teste

Ao pressionar a "tecla de testes" na UC (Unidade de Controle), o terminal de carga será ligado por 1 minuto.

Caso o apertar do botão cause uma situação de desconexão de carga (LVD/SOC, sobrecarga), a carga será imediatamente desligada.

PO

Recursos de Segurança

	Terminal Painel	Terminal da Bateria	Terminal de Carga
Polaridade reversa	Protegido (1)	Protegido (1)	Protegido (2)
Curto circuito(3)	Protegido	Protegido (4)	Desliga imediatamente
Sobrecarga	Não Atribuído	Não Atribuído	Desliga com retardo(5)
Corrente reversa	Protegido(6)	Não Atribuído	Não Atribuído
Sobretensão	Máx. 55 V (7)	Máx. 40 V	Desliga acima de 15,5/31,0 V
Subtensão	Não Atribuído	Não Atribuído	Desliga
Sobreaquecimento	Reduz a corrente de carga por PWM (modulação por largura de pulso) se ocorrer sobreaquecimento e desliga a carga se a temperatura alcançar um nível elevado.		

- (1) Tensão do painel e da bateria limitados a 60 V.
- (2) O controlador pode se proteger, mas as cargas podem ser danificadas.
- (3) Curto circuito: $>3x - 20x$ a corrente nominal.
- (4) A bateria deve ser protegida por fusível, caso contrário será danificada permanentemente se ocorrer curto-circuito.
- (5) $>200\%$ da corrente nominal: desligamento com retardo de 3s,
 $>150\%$ da corrente nominal: desligamento com retardo de 10s,
 $>110\%$ da corrente nominal: desligamento com retardo de 120s.

- (6) A corrente reversa através do painel solar é bloqueada por MOSFET serial. Essa função é testada e ativada aproximadamente 1 vez a cada 1min +/-5s.
- (7) A tensão do painel solar não deve exceder este limite por um longo período de tempo, já que a proteção de tensão é feita por um varistor.

ADVERTÊNCIA: A combinação de diferentes condições de erro pode causar danos ao controlador. Corrija sempre o erro antes de prosseguir com a conexão do controlador!

Função de Proteção contra Baixa Tensão (LVD)

- Estado de carga (SOC) controlado: Desconecte em 11,00/22,00 V a 11,70/23,40 V(SOC1), 11,12/22,24 V a 11,76/23,52 V(SOC2), 11,25/22,50 V a 11,83/23,63 V(SOC3), 11,38/22,72 V a 11,89/23,78 V(SOC4), 11,51/23,02 V a 11,96/23,92 V(SOC5), 11,64/23,28 V a 12,02/24,04 V(SOC6).
- Controlado por tensão (LVD): Desconecta a uma tensão fixa entre 11,0/22,0 V e 11,9/23,8 V (Passo 0,1/0,2 V).

Aviso: A tensão da bateria precisa estar abaixo do ajuste por mais de 2 minutos para que o LVD tenha efeito.

Aviso: Os dois níveis de tensão antes/depois da barra invertida são válidos para sistemas de 12 V e 24 V respectivamente (válido para os controladores de carga neste manual).

Ajustes de fábrica

É possível configurar os controladores de carga CIS-N-2L através da Unidade de Controle (UC). Consulte o manual da UC para detalhes.

	Ajuste de fábrica
Modo de carga	Controlador padrão(luz noturna desligada)
Proteção contra baixa tensão	SOC4
Tipo de bateria	Gel
Nível de luz noturna	8,0/16,0 V (1)
Horas noturnas - Carga 1	0 h
Horas matinais - Carga 1	0 h
Horas noturnas - Carga 2	0 h
Horas matinais - Carga 2	0 h

(1) Tensão em circuito aberto do painel fotovoltaico: Nível diurno = Nível noturno + 1,5/3,0 V

Nível de luz noturna

O controlador reconhece o dia e a noite baseado na tensão de circuito aberto do painel solar fotovoltaico. O ponto inicial entre dia e noite pode ser ajustado de acordo com as exigências das condições locais e o painel solar fotovoltaico utilizado.

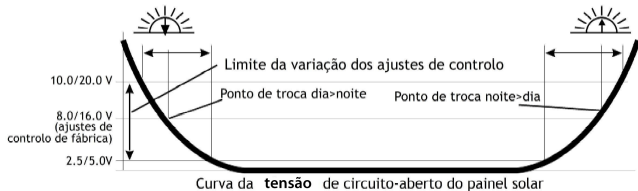

Para encontrar os valores corretos, recomendamos medir a tensão em circuito aberto do painel solar fotovoltaico no momento em que o anoitecer tenha alcançado o nível no qual o controlador deve mudar as cargas para "ligado" ou "desligado". Este valor (o mais aproximado disponível) pode então ser ajustado de acordo com a descrição na seção de programação.

Dados Técnicos

Aviso: Os dois níveis de tensão antes/depois da barra invertida são válidos para sistemas de 12 V e 24 V respectivamente.

Dados Técnicos	CIS-N-05-2L	CIS-N-10-2L	CIS-N-20-2L
Tensão do sistema	12/24 V reconhecimento automático		
Corrente máxima de carga	5 A**	10 A**	20 A**
Corrente de carga máx. por "string"	5 A**	10 A**	20 A**
Tensão de manutenção	13,8/27,6 V(25 °C)		
Carga principal	14,4 V (25° C), 0,5 h (diariamente)		
Tensão de carga rápida	14,4/28,8 V (25° C), 2 h ativação: tensão da bateria < 12,3/24,6 V		
Equalização	14,8/29,6 V (25° C), 2 h ativação: tensão da bateria < 12,1/24,2 V (pelo menos a cada 30 dias)		
Proteção contra descarga profunda Tensão de corte	11,00-12,02/22,00-24,04 V por SOC 11,0-11,9/22,0-23,8 V por tensão (escala ajustável 0,1/0,2V)		
Nível de reconexão	12,8/25,6 V		

Proteção contra sobretensão	15,5/31,0 V
Proteção contra subtensão	10,5/21,0 V
Tensão máxima do painel (Proteção contra sobretensão pelo varistor)	55 V
Tensão máxima da bateria	40 V
Compensação de temperatura (Tensão de carga)	-25/50 mV/K
Consumo próprio máx.	5 - 10 mA
Aterramento	A aterramento do negativo
Temperatura ambiente	-40 a +60° C
Altitude máxima	4.000 m acima do nível do mar
Tipo de bateria	chumbo-ácido (GEL, AGM, não-selada)
Faixa de ajuste: Horas noturnas Horas diurnas Detecção de noite Detecção de dia	0 - 15 h 0 - 14 h 2,5 - 10,0 V / 5,0 - 20,0 V (escala de ajuste 0,5/1,0 V) 4,0 - 11,5 V / 8,0 - 23,0 V (escala de ajuste 0,5/1,0 V)

Comprimento do condutor	10 cm
Dimensões(L x A x P)	82x63x20 mm
Peso	150 g
Seção transversal do condutor	AWG 13 (2.5 mm ²)
Tipo de proteção	IP68 (1,5 m, 72 h)

PO

** : A 60°C, o CIS só pode apresentar corrente máxima no painel ou na carga, não simultaneamente.

Exclusão de Responsabilidade

O fabricante exime-se de responsabilidade por quaisquer danos, especialmente à bateria, que possam ser originados pela utilização para quaisquer outros fins que não aqueles especificamente indicados ou mencionados neste manual ou consequentes da inobservância das recomendações do fabricante da bateria. O fabricante fica eximido de responsabilidade se a revisão ou o reparo tiverem sido realizados por uma pessoa não autorizada ou se o dano for consequente de uso impróprio, instalação incorreta ou sistema inaderuado projetado.

PO

Sujeito a alterações sem aviso. Versão: 20130730

Fabricado em um dos países seguintes:

Alemanha - China - Bolívia - Índia

Phocos AG - Alemanha

www.phocos.com

ISO9001

 RoHS

亲爱的用户：非常感谢您选用伏科产品！在使用本产品前，请仔细阅读本手册。新一代的 CIS-N-2L 控制器，是一款根据最新技术标准开发的，代表最新工业水平的产品。此产品拥有许多卓越的特征：

- 共负极和双负载。
- 防护等级：IP68，1.5 m 水深，72 小时内不受损。
- 控制器本身无任何按键，红外遥控器(CU)设置工作模式。
- 外置温度传感器，测量环境温度更准确，温度补偿更精确。
- 铅酸电池 4 段式充电 (工充，强充，均衡充，浮充)，胶体电池 3 段式充电(工充，强充，浮充)。
- 12/24V 系统电压自动识别。
- 先进的可编程功能，可灵活设定夜间照明时间。

接线和接地

- 为避免安装错误，请按照图中数字标出的顺序连线。
- 为了避免电缆上的电压，请首先连接控制器端，然后是蓄电池、太阳能电池板和负载。
- 推荐线径：CIS05: 2.5 mm²; CIS10: 6.0 mm²; CIS20: 10.0 mm²。
- 电线上的压降过高会引起的控制器误判，因此请确保蓄电池和控制器之间的电缆尽可能得短。
- CIS-N-2L 控制器的负极端子是连载一起的，有相同的电势。因此如果系统需要接地，只允许负极接地。

	功能	热缩管标识	线径规格	颜色
①	蓄电池负极	COMMON -	AWG 13 (2.5 mm ²)	黑色
②	蓄电池正极	BATTERY +	AWG 13 (2.5 mm ²)	红色
③	电池板负极	COMMON -	AWG 13 (2.5 mm ²)	黑色
④	电池板正极	SOLAR +	AWG 13 (2.5 mm ²)	黄色
⑤	负载 1 负极	COMMON -	AWG 13 (2.5 mm ²)	黑色
⑥	负载 1 正极	LOAD 1 +	AWG 13 (2.5 mm ²)	橙色
⑦	负载 2 负极	COMMON -	AWG 13 (2.5 mm ²)	黑色
⑧	负载 2 正极	LOAD 2 +	AWG 13 (2.5 mm ²)	橙色

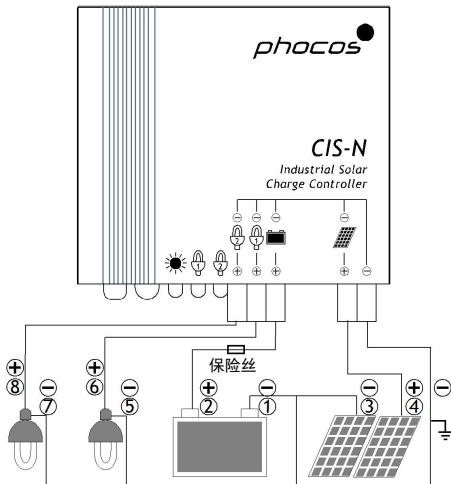

显示和报警功能

指示灯	状态	功能
	点亮	蓄电池连接到控制器上，时间为夜晚
	闪烁	蓄电池连接到控制器上，时间为白天
	关闭	没有连接蓄电池
	点亮	负载 1 低压切断或高压保护
	闪烁	负载 1 过流
	关闭	负载 1 正常
	点亮	负载 2 低压切断或高压保护
	闪烁	负载 2 过流
	关闭	负载 2 正常
所以指示灯	循环点亮	编程中

路灯功能

CIS-N-2L 控制器具有先进的路灯控制功能。负载点亮时间和方式都可以根据客户需要灵活的编程。

有3种模式可供选择：

通用控制器、黄昏到清晨和夜晚/清晨两段式模式。

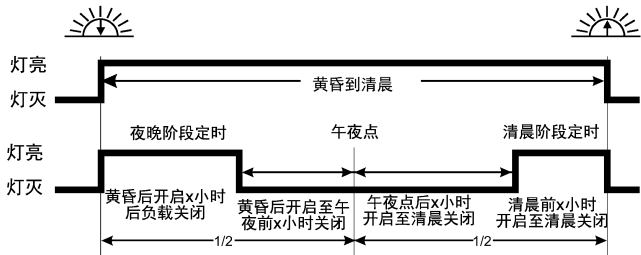

“午夜点”的确定，控制器会根据实际的黄昏与清晨的持续时间，自动识别中点，也就是控制器认为的午夜点，不需要用户设定真正的时间。控制器自动确认准确的午夜点需要

几天时间的运行。这种方式可能在某些时候不是太准确，但是可以避免用户在不同的季节对时钟进行校核。控制器确定的午夜点与实际时间的午夜是不相同的。

控制器通过测量太阳能电池的开路电压，识别白天和黑夜。

根据所处不同地区和不同太阳能电池板，用户可以自行设置不同的光控点电压（白天和黑夜的临界电压）。

测试功能

在遥控器(CU)上，有一测试按键(Test)。按此按键可将控制器的负载端打开1分钟。

在白天，CIS-N-2L的测试功能可以帮助用户判断系统安装是否正确，也可以帮助排除故障。如果按编程按钮打开负载后，导致系统进入LVD(放电保护)状态，负载会自动关闭。当系统处于LVD状态时，测试功能不可用。

安全特性

	太阳能端	蓄电池端	负载端
极性反接	保护 (1)	保护 (1)	保护 (2)
短路(3)	保护	保护 (4)	立即切断
过流	N/A	N/A	延时切断(5)
反向充电电流	保护(6)	N/A	N/A
过压	最高 55 V (7)	最高 40 V	大于 15.5/31.0V 立即切断
欠压	N/A	N/A	切断负载
过温	当温度过高时，控制器会用 PWM 方式限制充电电流；如果温度达到一定的高度，控制器会切断负载。		

- (1) Upanel - Ubattery \leq 60V。MOSFET 最高承受电压为 60V。
- (2) 控制器能够保护自己，负载可能会损坏。
- (3) 实际电流大于 3 倍额定电流被认定为短路。
- (4) 我们强烈建议在蓄电池和控制器之间接上保险丝。如果有短路情况的话，蓄电池可能会永久性损坏。
- (5) >200% 额定电流: 延时 3 s 切断负载,
>150% 额定电流: 延时 10 s 切断负载,

>110% 额定电流: 延时 120 s 切断负载。

(6) 控制器靠 MOSFET 实现反向电流保护功能。控制器每分钟检测一次电流流向。

(7) 太阳能端是靠变阻器分压实现保护功能的, 因此太阳能端电压不能长时间高于 55 V。

警告: 两个或两个以上的错误条件同时存在时很有可能损坏控制器, 所以在继续下一步操作前, 首先要排除现有故障。

低压切断功能

- 蓄电池电量方式(SOC)控制: 切断电压范围
11.00/22.00 V 至 11.70/23.40 V(SOC1), 11.12/22.24 V 至 11.76/23.52 V(SOC2),
11.25/22.50 V 至 11.83/23.63 V(SOC3), 11.38/22.72 V 至 11.89/23.78 V(SOC4),
11.51/23.02 V 至 11.96/23.92 V(SOC5), 11.64/23.28 V 至 12.02/24.04 V(SOC6).
- 蓄电池电压(LVD)控制: 切断电压固定, 11.0/22.0 V 至 11.9/23.8 V 范围内可调(调整精度 0.1/0.2 V).

注意: 蓄电池电压低于设定点, 经过后 2 分钟以上的延迟后切断负载。

注意: 斜杠 '/' 前后的数值分别表示在 12 V 和 24 V 系统中的相应电压值。

出厂设置

CIS-N-2L 控制器是通过遥控器 (CU) 进行设置的, 详细的设置信息请见 CU 说明书。

	出厂设置
负载控制方式	通用控制器(路灯功能关闭)
低压保护方式	SOC4
蓄电池类型	胶体
夜晚识别电压	8.0/16.0V (1)
负载 1 夜晚时间	0 h
负载 1 清晨时间	0 h
负载 2 夜晚时间	0 h
负载 2 清晨时间	0 h

(1) 这里指的是太阳能电池板开路电压。白天识别电压= 夜晚识别电压 +1.5/3.0V

光控点

控制器通过测量太阳能电池板得开路电压识别白天和黑夜。用户可以自行设置光控点电压以适应不同地区和不同类型的太阳能电池板。

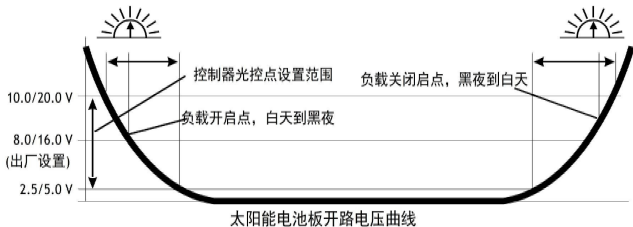

如何找到准确的光控点，我们推荐，用户在黄昏或凌晨来临时（即控制器打开或关闭负载端时），测量太阳能电池板的开路电压。用户设置控制器的光控点电压最接近此值即可。

技术参数

注意: 斜杠 '/' 前后的数值分别表示在 12V 和 24V 系统中的相应电压值。

技术参数	CIS-N-05-2L	CIS-N-10-2L	CIS-N-20-2L
系统电压	12/24 V 自动识别		
最大充电电流	5 A**	10 A**	20 A**
单路最大放电电流	5 A**	10 A**	20 A**
浮充电压	13.8/27.6 V(25 °C)		
主充电压	14.4 V (25 °C), 0.5 小时/天		
强充电压	14.4/28.8 V (25 °C), 2 小时/次 蓄电池电压 < 12.3/24.6 V 激活		
均衡充电压	14.8/29.6 V (25 °C), 2 小时/次 蓄电池电压 < 12.1/24.2 V 激活 (每间隔 30 天至少一次)		
过放保护 切断电压	11.00-12.02/22.00-24.04 V 蓄电池电量控制 11.0-11.9/22.0-23.8 V 蓄电池电压控制 (调整精度 0.1/0.2 V)		

恢复电压	12.8/25.6V
过压保护	15.5/31.0V
欠压保护	10.5/21.0V
最大太阳能电池板电压 (压敏电阻过压保护)	55V
最大蓄电池电压	40V
温度补偿(充电电压)	-25/50 mV/K
自消耗电流	5 - 10 mA
接地	共负极设计, 只允许负极接地
环境温度范围	-40 至 +60 °C
最高海拔	4,000 m
蓄电池类型	铅酸电池(胶体, AGM, 液体)
可调范围: 夜晚运行时间 清晨运行时间 夜晚识别电压 白天识别电压	0 - 15 h 0 - 14 h 2.5 - 10.0V / 5.0 - 20.0V (调整精度 0.5/1.0 V) 4.0 - 11.5V / 8.0 - 23.0V (调整精度 0.5/1.0 V)
电缆长度	10 cm

尺寸(WXHXD)	82x63x20 mm
重量	150 g
线径要求	AWG 13 (2.5 mm ²)
防护等级	IP68 (1.5 m, 72 h)

**：如果环境温度超过 60°C，只能在太阳能端或负载端一端满载运行，不能同时满载。

免责声明

生产商不承担，由于违反本手册建议或提及的规范，以及忽视蓄电池生产商的建议而造成的任何损坏。如果有由非生产商指定人员提供维护服务、不正常使用、错误安装或者错误的系统设计情况出现，生产商不承担任何责任。

如有更改，恕不另行通知。 版本：20130730

在以下国家生产：

德国 - 中国 - 玻利维亚 - 印度

Phocos AG - Germany

www.phocos.com

ISO9001

CE RoHS